

END-SUCTION CENTRIFUGAL STAINLESS STEEL

Series: CD
1 - 3 HP



SUCTION

CD70: 1¼" NPT horizontal.
CD120 & CD200: 1½" NPT horizontal.

DISCHARGE

1" & 1¼" NPT vertical.

LIQUID TEMPERATURE

158 °F (70 °C).

MAX. WORKING PRESSURE

125 psi (8.8 kg/cm²).

BODY

304 series stainless steel.

IMPELLER

Design: close type.

Material: 304 series stainless steel.

SEAL

Design: mechanical type 21, lubricated by water.

Material: ceramic stationary part, carbon ring seal and exclusion in the rotating part. Buna-N elastomer and stainless steel spring.

BRACKET

304 series stainless steel.

HARDWARE

304 series stainless steel.

O-RING

Buna-N.

SHAFT

316 series stainless steel.

MOTOR

IE2, TEFC, 3450 RPM (2 poles), 60 Hz, three phase 230/460 volts, protection class IP55 and insulation class F.

Requires overload to be included in control panel.

OPTIONAL EQUIPMENT

Viton® seal for high temperature.

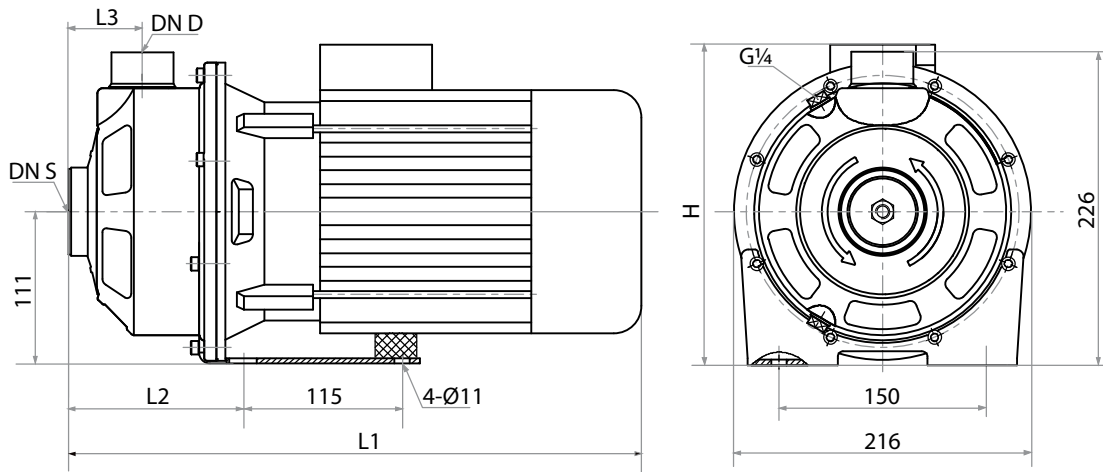

MODEL	PART No.	SIZE	HP	PHASE	VOLTS	L1	L2	L3	H	WEIGHT (pounds)
						INCHES				
CD70-1-2	70080051	1¼" x 1"	1	3	230/460	14.2	4.4	2	8.7	30.8
CD70-1.5-2	70080052	1¼" x 1"	1.5	3	230/460	14.2	4.4	2	8.7	30.8
CD70-1.5-2 VS	70080052B	1¼" x 1"	1.5	3	230/460	-	-	-	-	30.8
CD70-2-2	70080053	1¼" x 1"	2	3	230/460	15.7	4.4	2	9.1	44
CD70-2-2 VS	70080053B	1¼" x 1"	2	3	230/460	-	-	-	-	44
CD120-1.5-2	70080061	1½" x 1¼"	1.5	3	230/460	14.7	4.9	2.1	8.7	35.2
CD120-1.5-2 VS	70080061B	1½" x 1¼"	1.5	3	230/460	-	-	-	-	35.2
CD120-2-2	70080062	1½" x 1¼"	2	3	230/460	16.3	4.9	2.1	9.1	44
CD120-2-2 VS	70080062B	1½" x 1¼"	2	3	230/460	-	-	-	-	44
CD120-3-2	70080063	1½" x 1¼"	3	3	230/460	16.3	4.9	2.1	9.1	50.7
CD120-3-2 VS	70080063B	1½" x 1¼"	3	3	230/460	-	-	-	-	50.7
CD200-1.5-2	70080071	1½" x 1¼"	1.5	3	230/460	14.7	4.9	2.1	8.7	44
CD200-1.5-2 VS	70080071B	1½" x 1¼"	1.5	3	230/460	-	-	-	-	44
CD200-3-2	70080072	1½" x 1¼"	3	3	230/460	16.3	4.9	2.1	9.1	50.7
CD200-3-2 VS	70080072B	1½" x 1¼"	3	3	230/460	-	-	-	-	50.7

VS= Viton seal

IMPORTANT!

1. Never use this pump to handle explosive liquids.

Scope of performance

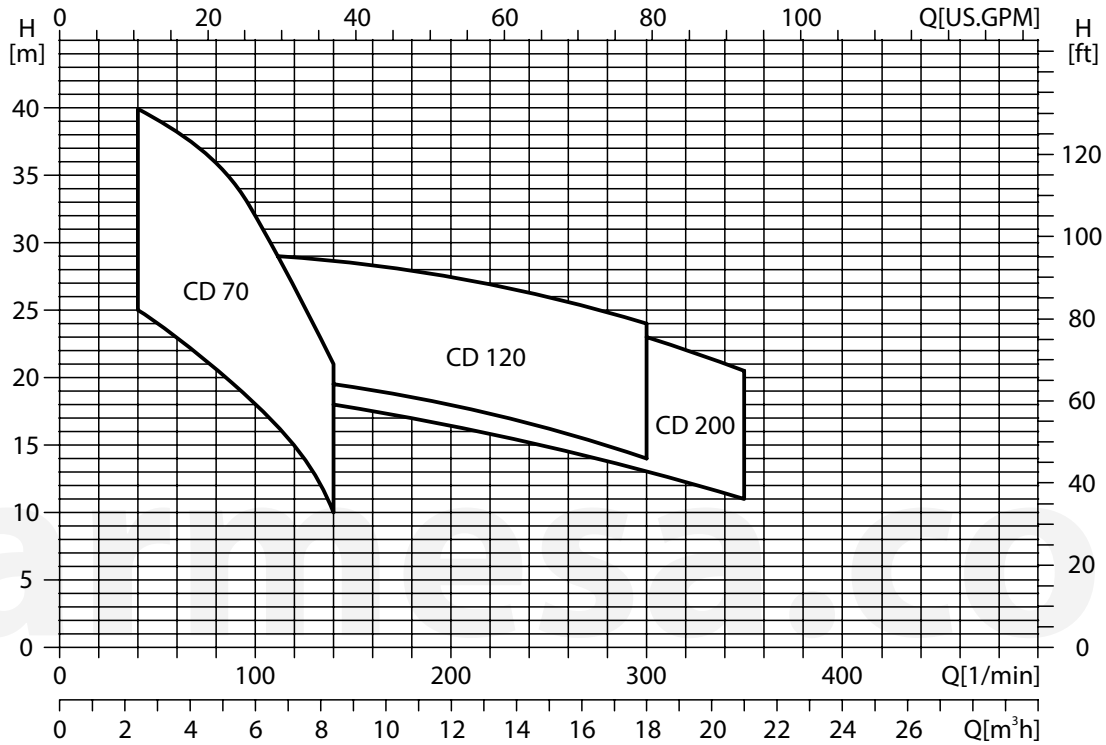

MODEL	DRIVING MOTOR		Q (1/min)	20	40	60	80	100	120	140	160	200	250	300	330	350	
	(kW)	(HP)	Q (m³/h)	1.2	2.4	3.6	4.8	6.0	7.2	8.4	9.6	12	15	18	20	21	
CD70-1-2	0.75	1	H (m)		25	23	21	17	15	10							
CD70-1.5-2	1.1	1.5			33	31	29	25	21	15							
CD70-2-2	1.5	2			40	38	36	32	27	22							
CD120-1.5-2	1.1	1.5							20.5	20	19.5	19	18	17	14		
CD120-2-2	1.5	2							25.5	25	24.5	24	23	22	20		
CD120-3-2	2.2	3							29	28.8	28.5	28	27.5	26	24		
CD200-1.5-2	1.1	1.5								18.5	18	17.5	16.5	15	13	12	11
CD200-3-2	2.2	3								28.5	28	27.5	26.5	25	23	21.5	20.5

CD 70

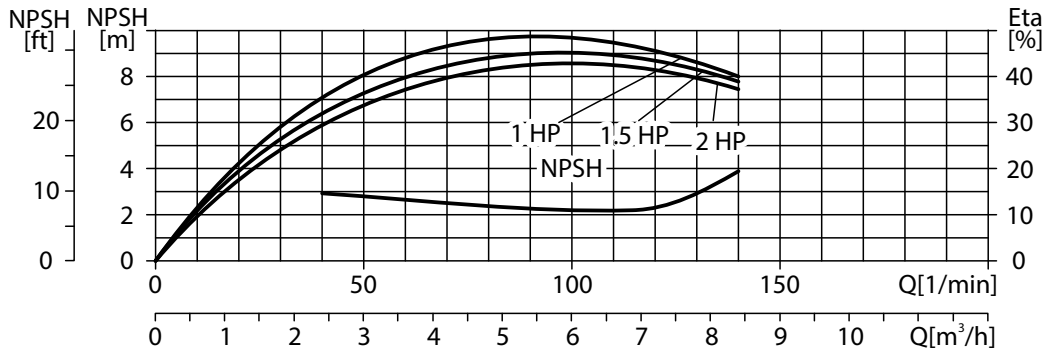
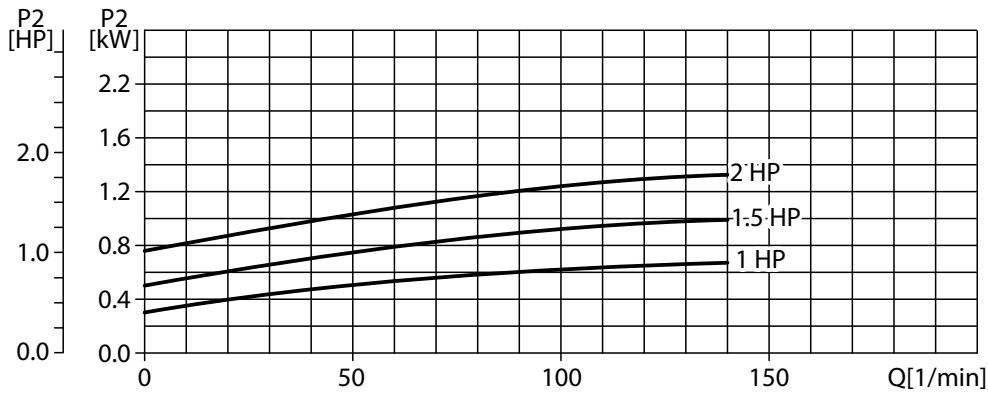
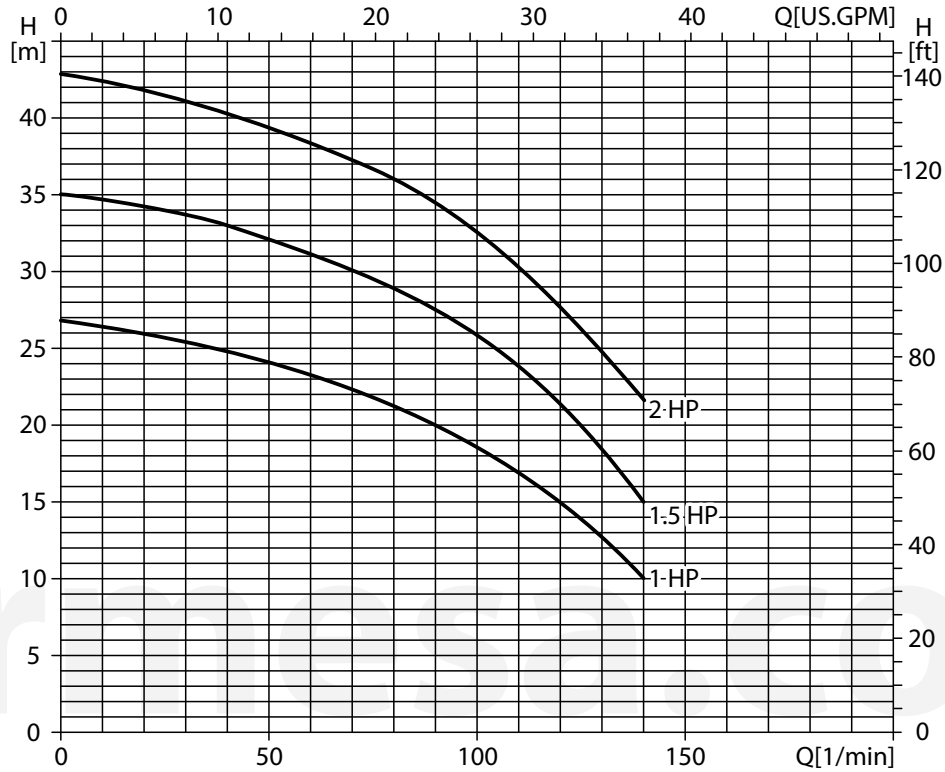

CD 120

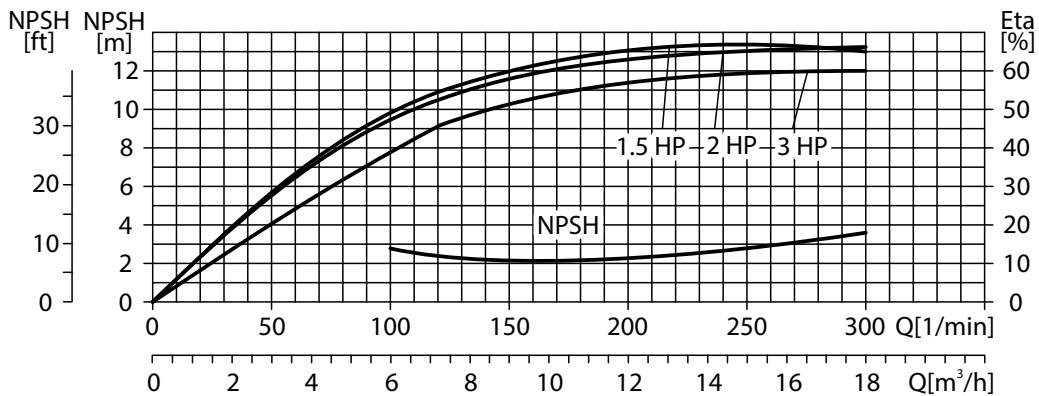
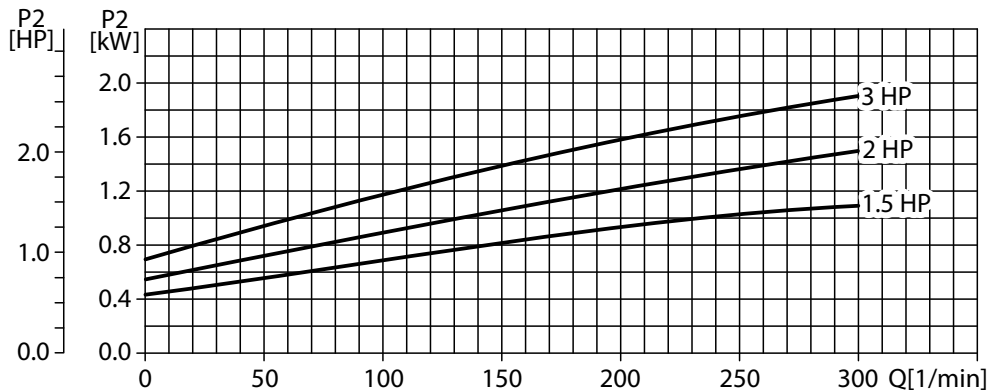
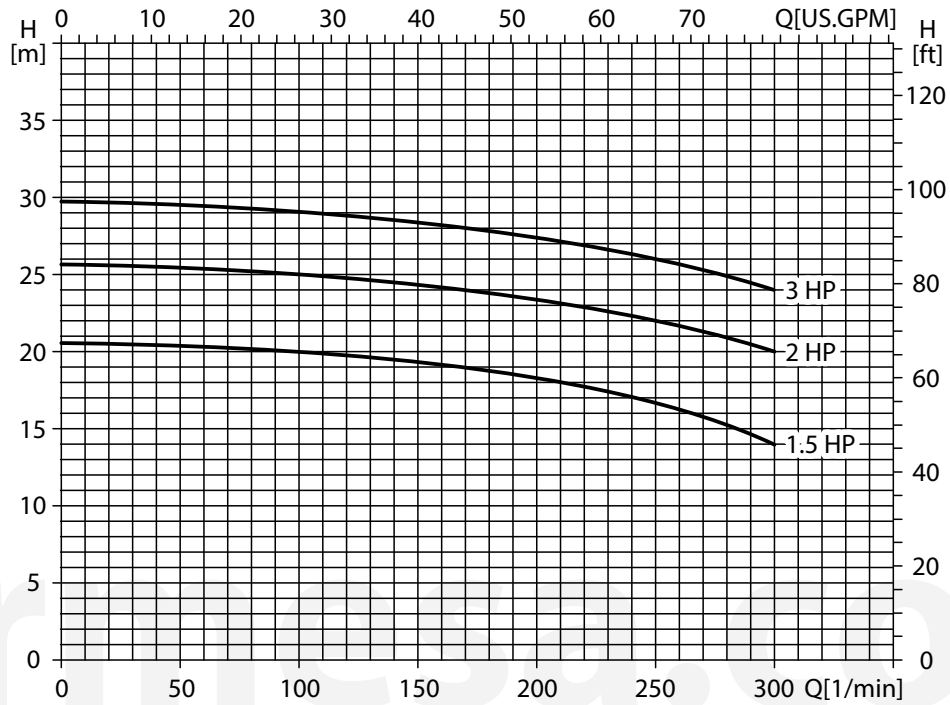

CD 200

