

SELF-PRIMING FRAME MOUNTED PUMPS

Series: BSP20ICU
3" x 3"
Universal Drive



SUCTION/DISCHARGE

3" x 3" NPT, female.

LIQUID TEMPERATURE

Continuous: 160 °F (71 °C)

VOLUTE

Cast iron ASTM A-48 class 30

BODY

Cast iron ASTM A-48 class 30

PEDESTAL

Cast iron ASTM A-48 class 30

IMPELLER

Design: open, trash type, dynamically balanced.

Material: cast iron ASTM A-48 class 30

SHAFT

Stainless steel

HARDWARE

Steel & stainless steel

O-RINGS

Buna-N

PAINT

Air dry enamel, water based.

SEAL

Design: single mechanical with lip seal, water lubricated.

Material: ceramic stationary part, carbon ring seal and exclusion in the rotating part. Buna-N elastomer and stainless steel spring.

CHECKVALVE

Valve: flap-neoprene

Weight: steel

BEARING-DRIVE END

Single row, ball, grease lubricated.

BEARING-PUMP END

Single row, ball, grease lubricated.

OPTIONAL

Bronze fitted volute and impeller

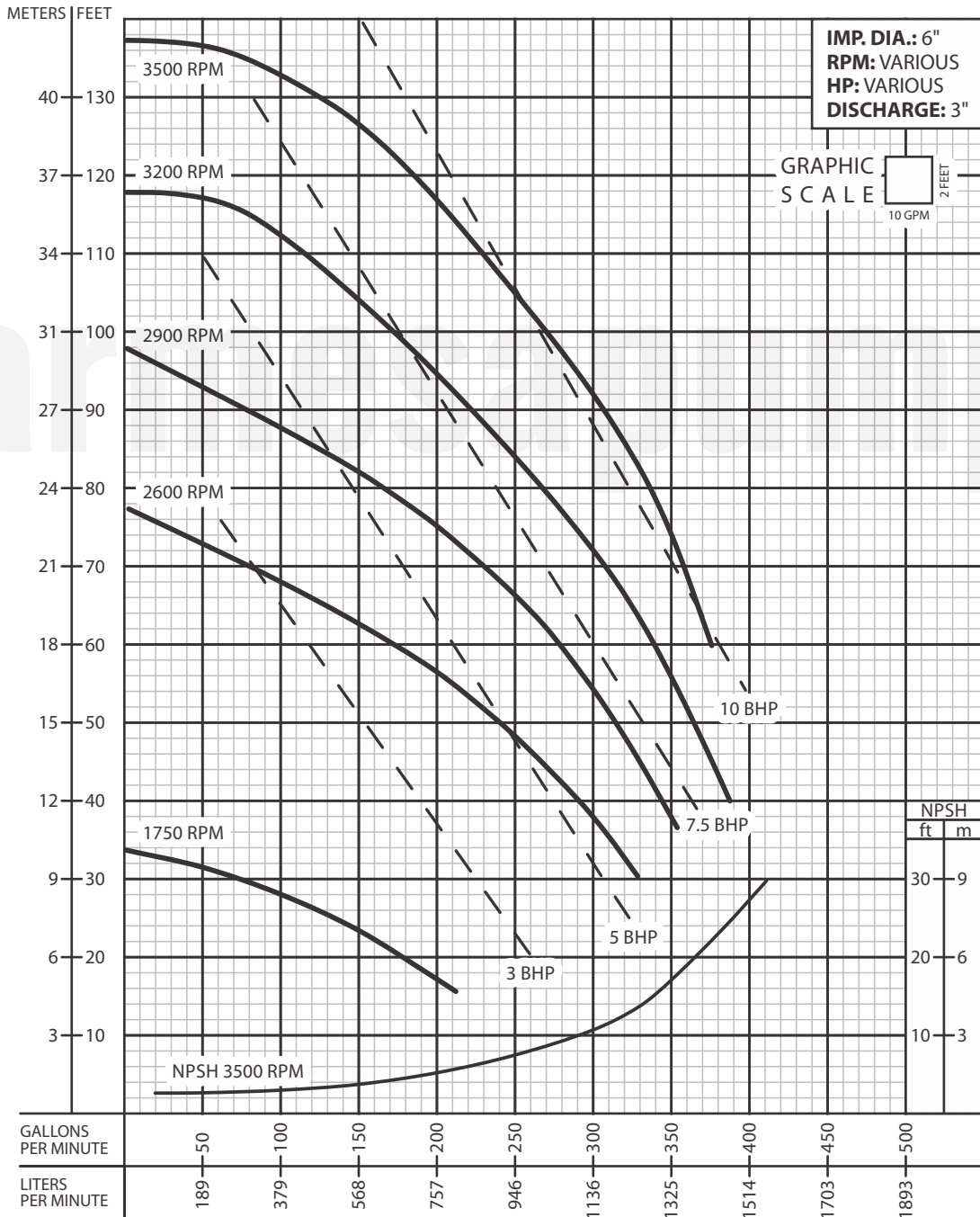
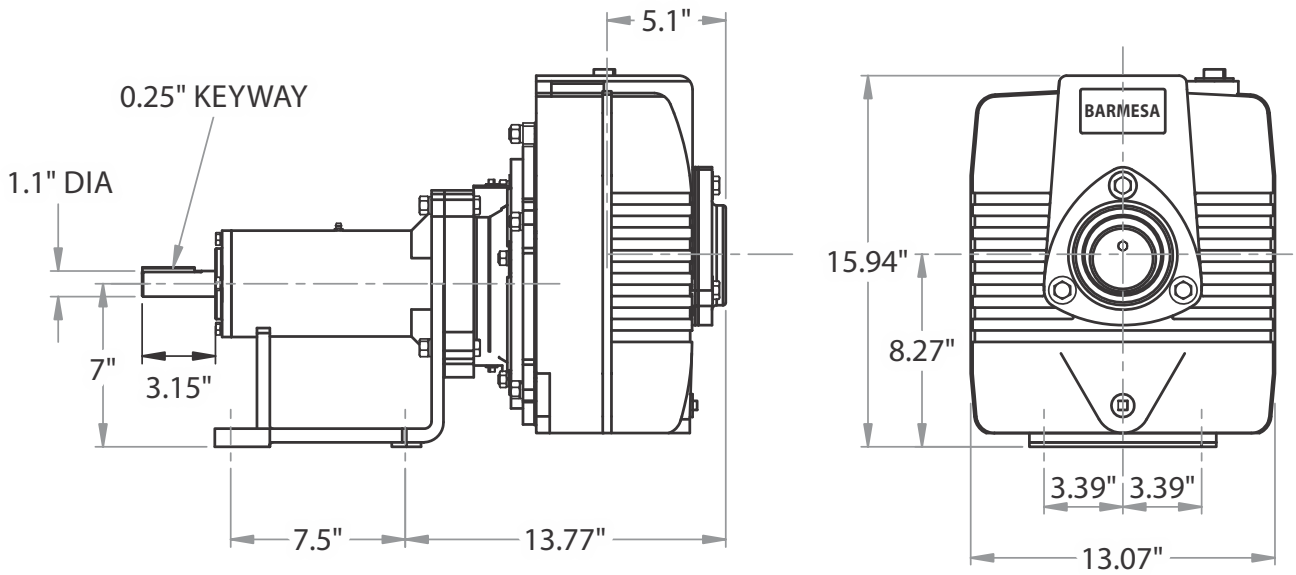

IMPORTANT!

1. Testing is performed with water specific gravity of 1.0 @ 68 °F (20 °C); other fluids may vary performance.