

HIGH EFFICIENCY VERTICAL MULTISTAGE CENTRIFUGAL PUMP

Series: **HMV70-90-2503**
25 HP



CSA
C US
CSA Certified
Drinking Water -
NSF/ANSI 61 & 372

* Representative image

TECHNICAL DATA								
MODEL	PART No.	HP	RPM	V	MAX. AMPS	MAX. TEMP. (°F)	MAX. Q (gpm)	MAX. H (ft)
HMV70-10-303	70120109A	3	3500	230/460	7.9/3.9	248	102	82
HMV70-20-553	70120109B	5.5	3500	230/460	13.5/6.7	248	102	164
HMV70-30-753	70120109C	7.5	3500	230/460	18.3/9.1	248	102	246
HMV70-40-1003	70120109D	10	3500	230/460	24.7/12.3	248	102	327
HMV70-50-1503	70120109L	15	3500	230/460	34/17	248	102	409
HMV70-60-1503	70120109E	15	3500	230/460	34/17	248	102	492
HMV70-70-2003	70120109N	20	3500	230/460	46/23	248	102	573
HMV70-80-2003	70120109F	20	3500	230/460	46/23	248	102	656
HMV70-90-2503	70120109P	25	3500	230/460	56.5/28.2	248	102	738
HMV70-100-2503	70120109G	25	3500	230/460	56.5/28.2	248	102	820

ITEM	NAME	MATERIAL	AISI/ASTM
1	Motor	-	-
2	Bracket	Ductile cast iron	ASTM A536 65-45-12
3	Seal base	Stainless steel	AISI 304
4	Mechanical seal	SiC/Carbon	-
5	Top diffuser	Stainless steel	AISI 304
6	Diffuser	Stainless steel	AISI 304
7	Support diffuser	Stainless steel	AISI 304
8	Coupling	Ductile iron	ASTM A536 65-45-12
9	Impeller	Stainless steel	AISI 304
10	Cylinder	Stainless steel	AISI 304
11	Shaft	Stainless steel	AISI 304
12	Bearing	Tungsten carbide	-
13	Inducer	Stainless steel	AISI 304
14	Inlet & outlet chamber	Stainless steel	AISI 304
15	Base	Cast iron	ASTM 25B

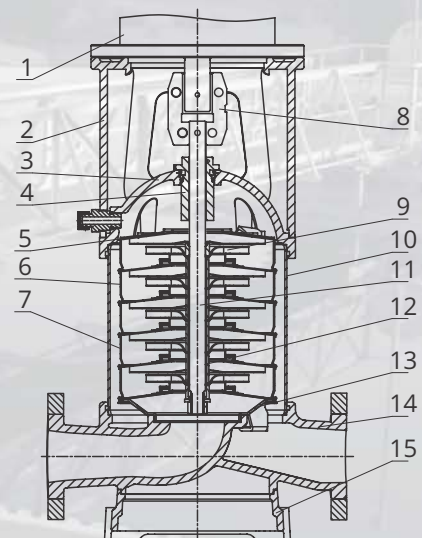

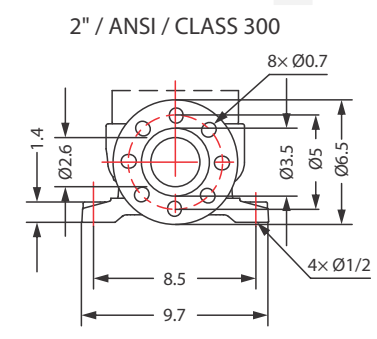
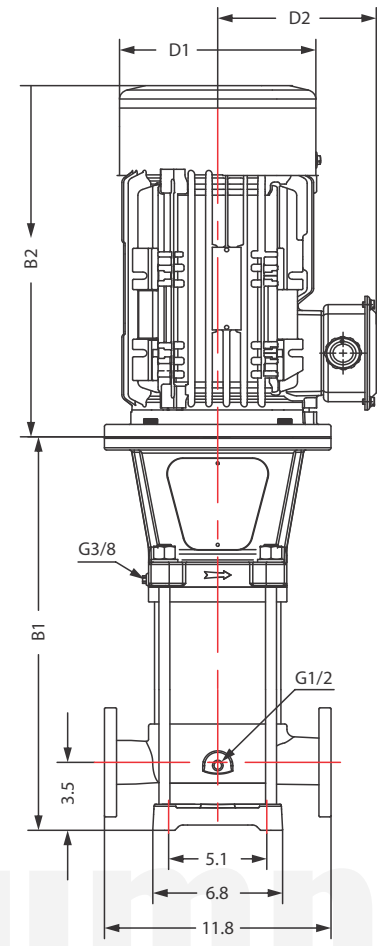
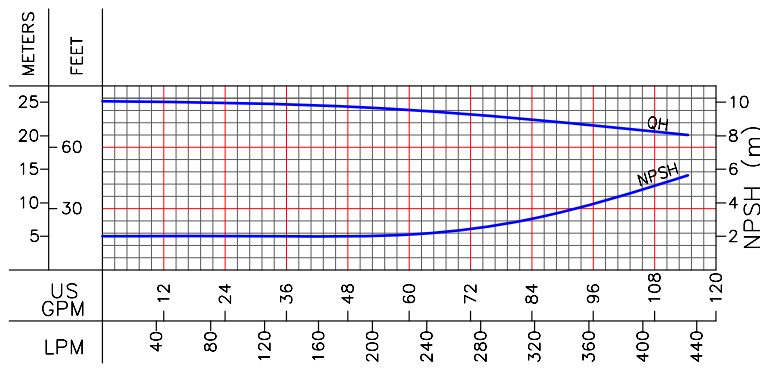
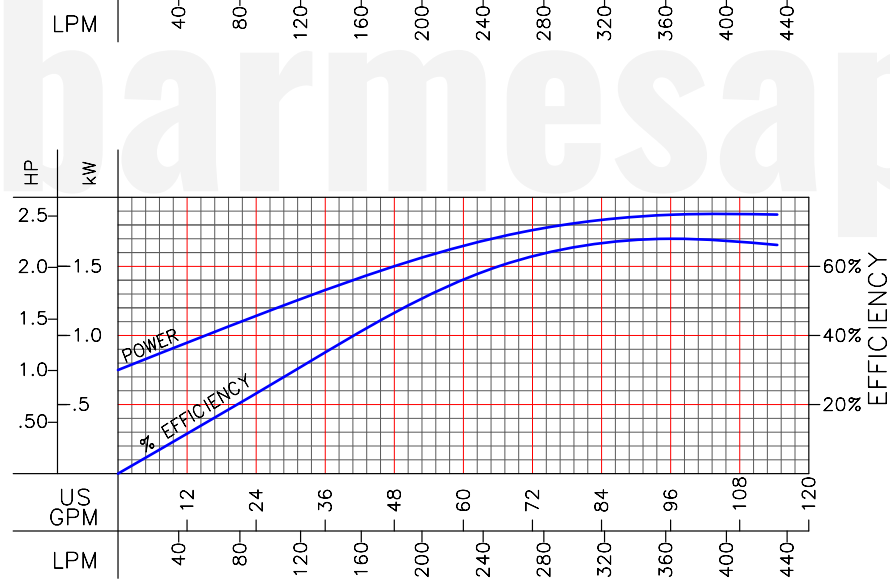
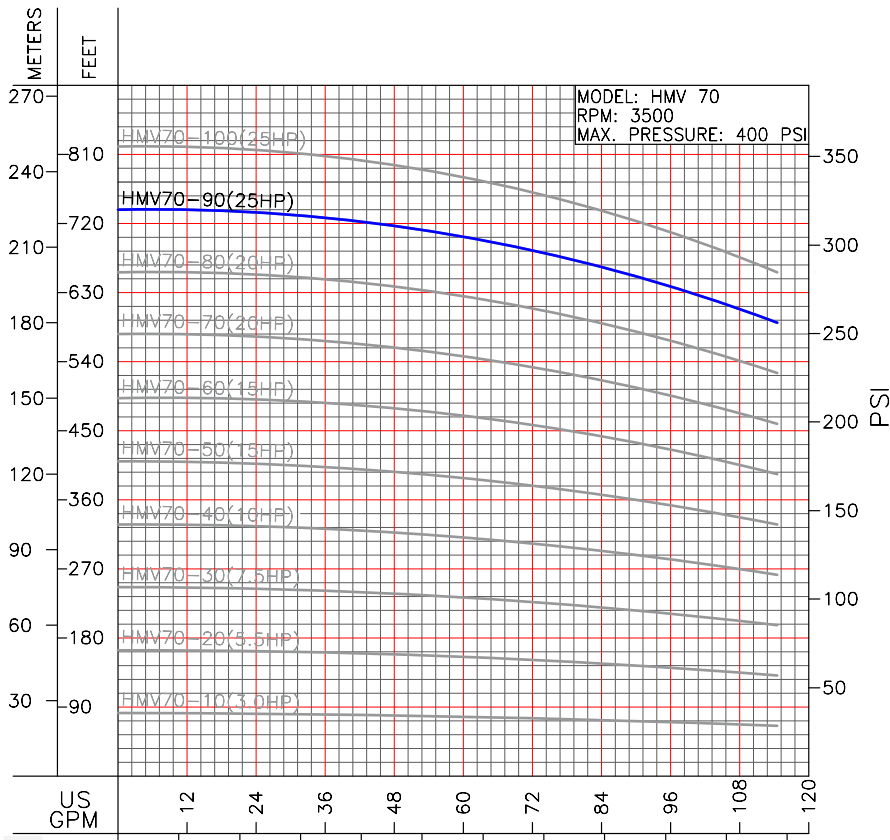

MODEL	HP	STAGES	SIZE (in)				WEIGHT (lb)	
			B1	B2	B1+B2	D1		D2
HMV70-10-303	3	1	14	14	28	7	6	68
HMV70-20-553	5.5	2	16	16	32	9	7	106
HMV70-30-753	7.5	3	19	18	37	10	8	159
HMV70-40-1003	10	4	21	18	39	10	8	181
HMV70-50-1503	15	5	26	24	50	14	10	331
HMV70-60-1503	15	6	28	24	52	14	10	335
HMV70-70-2003	20	7	29	24	53	14	10	364
HMV70-80-2003	20	8	31	24	55	14	10	366
HMV70-90-2503	25	9	33	25	58	14	10	403
HMV70-100-2503	25	10	35	25	60	14	10	406