

HIGH EFFICIENCY VERTICAL MULTISTAGE CENTRIFUGAL PUMP

Series: **HMV22-110-553**
5.5 HP



CSA
C US
CSA Certified
Drinking Water -
NSF/ANSI 61 & 372

* Representative image

TECHNICAL DATA

MODEL	PART No.	HP	RPM	V	MAX. AMPS	MAX. TEMP. (°F)	MAX. Q (gpm)	MAX. H (ft)
HMV22-30-153	70120105A	1.5	3500	230/460	4.2/2.1	248	35	130
HMV22-40-203	70120105B	2	3500	230/460	5.5/2.7	248	35	170
HMV22-60-303	70120105C	3	3500	230/460	7.9/3.9	248	35	262
HMV22-90-403	70120105D	4	3500	230/460	10.3/5.1	248	35	390
HMV22-110-553	70120105E	5.5	3500	230/460	13.5/6.7	248	35	478
HMV22-150-753	70120105F	7.5	3500	230/460	18.3/9.1	248	35	640

ITEM	NAME	MATERIAL	AISI/ASTM
1	Motor	-	-
2	Bracket	Ductile cast iron	ASTM A536 65-45-12
3	Seal base	Stainless steel	AISI 304
4	Mechanical seal	SiC/Carbon	-
5	Top diffuser	Stainless steel	AISI 304
6	Diffuser	Stainless steel	AISI 304
7	Support diffuser	Stainless steel	AISI 304
8	Coupling	Ductile cast iron	ASTM A536 65-45-12
9	Impeller	Stainless steel	AISI 304
10	Cylinder	Stainless steel	AISI 304
11	Shaft	Stainless steel	AISI 304
12	Bearing	Tungsten carbide	-
13	Inducer	Stainless steel	AISI304
14	Inlet & outlet chamber	Stainless steel	AISI 304
15	Base	Cast iron	ASTM 25B

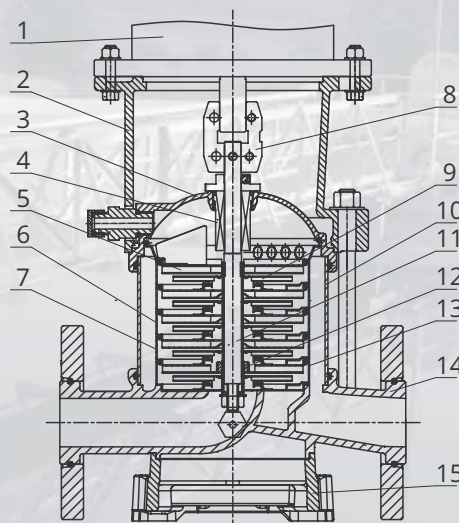

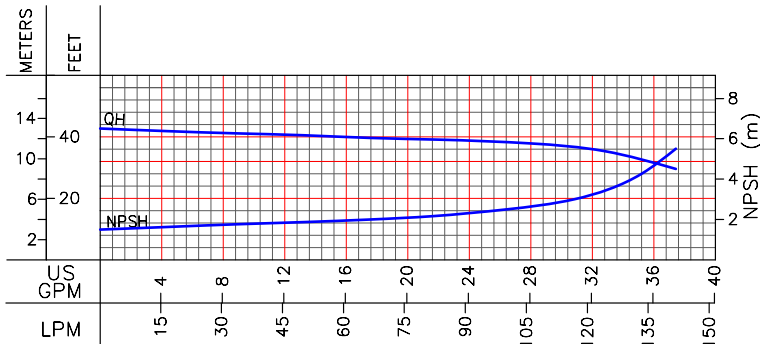
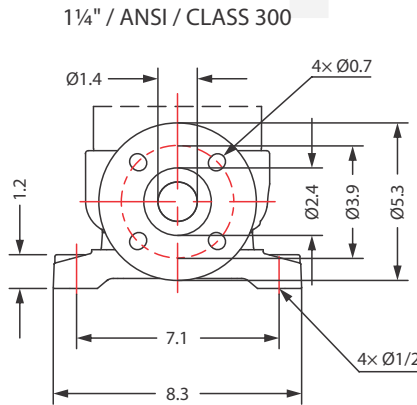
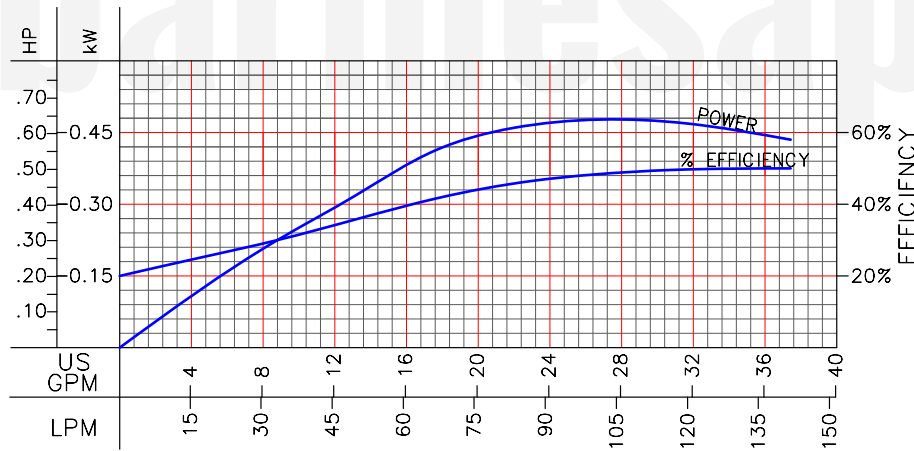
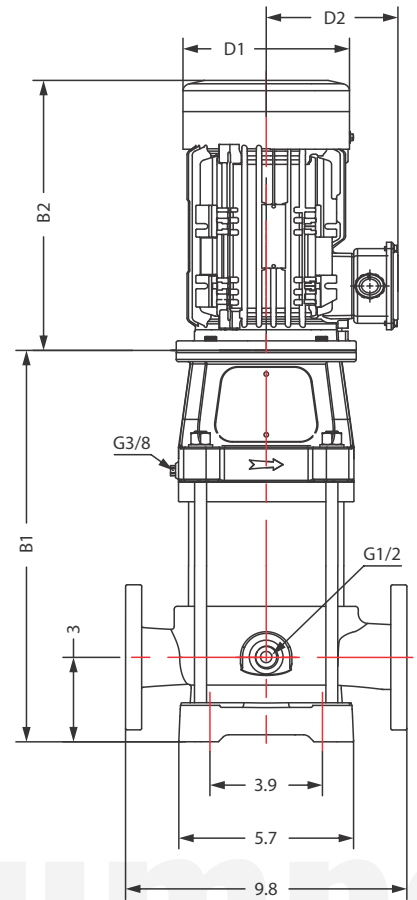
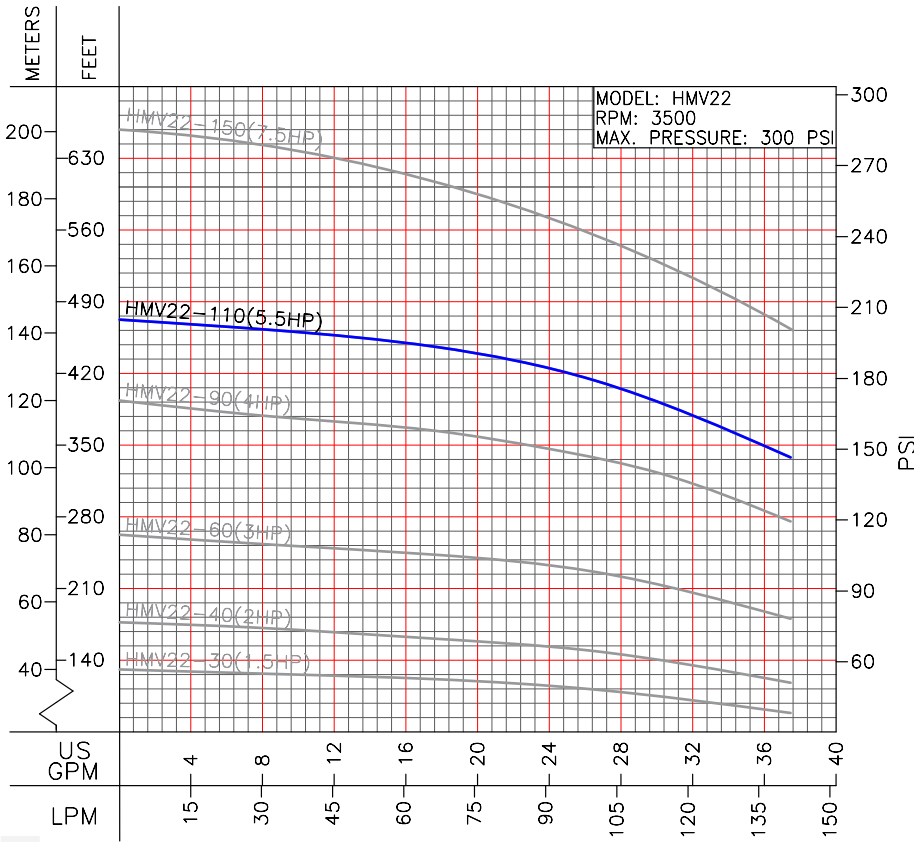

MODEL	HP	STAGES	SIZE (in)				WEIGHT (lb)	
			B1	B2	B1+B2	D1		D2
HMV22-30-153	1.5	3	12	11	24	7	6	71
HMV22-40-203	2	4	14	14	28	7	6	77
HMV22-60-303	3	6	16	14	30	7	6	86
HMV22-90-403	4	9	20	16	36	8	6	104
HMV22-110-553	5.5	11	22	16	38	9	7	123
HMV22-150-753	7.5	15	27	18	45	10	8	148