

# HIGH EFFICIENCY VERTICAL MULTISTAGE CENTRIFUGAL PUMP

Series: **HMV140-60-4003**  
40 HP



**CSA**<sup>®</sup>  
C US  
CSA Certified  
Drinking Water -  
NSF/ANSI 61 & 372

\* Representative image

TECHNICAL DATA								
MODEL	PART No.	HP	RPM	V	MAX. AMPS	MAX. TEMP. (°F)	MAX. Q (gpm)	MAX. H (ft)
HMV140-10-1-553	70120113A	5.5	3500	230/460	13.5/6.7	248	200	95
HMV140-10-753	70120113B	7.5	3500	230/460	18.3/9.1	248	200	101
HMV140-20-2-1003	70120113N	10	3500	230/460	24.7/12.3	248	200	197
HMV140-20-1003	70120113C	10	3500	230/460	24.7/12.3	248	200	213
HMV140-30-2-1503	70120113D	15	3500	230/460	34/17	248	200	295
HMV140-30-2003	70120113P	20	3500	230/460	46/23	248	200	327
HMV140-40-2-2003	70120113E	20	3500	230/460	46/23	248	200	400
HMV140-40-2503	70120113R	25	3500	230/460	56.5/28.2	248	200	429
HMV140-50-2-2503	70120113F	25	3500	230/460	56.5/28.2	248	200	508
HMV140-50-3003	70120113T	30	3500	230/460	66.9/33.5	248	200	524
HMV140-60-2-3003	70120113G	30	3500	230/460	66.9/33.5	248	200	606
HMV140-60-4003	70120113V	40	3500	230/460	90.7/45.4	248	200	629
HMV140-70-2-4003	70120113X	40	3500	230/460	90.7/45.4	248	200	704
HMV140-70-4003	70120113H	40	3500	230/460	90.7/45.4	248	200	731
HMV140-80-5003	70120113Z	50	3500	230/460	111/55.7	248	200	806
HMV140-90-2-5003	70120113I	50	3500	230/460	111/55.7	248	200	895
HMV140-90-5003	70120113Z2	50	3500	230/460	111/55.7	248	200	921
HMV140-100-2-6006	70120113Z4	60	3500	230/460	134/66.8	248	200	1016
HMV140-100-6003	70120113J	60	3500	230/460	134/66.8	248	200	1032

ITEM	NAME	MATERIAL	AISI/ASTM
1	Motor	-	-
2	Bracket	Ductile cast iron	ASTM A536 65-45-12
3	Seal base	Stainless steel	AISI 304
4	Mechanical seal	SiC/Carbon	-
5	Top diffuser	Stainless steel	AISI 304
6	Diffuser	Stainless steel	AISI 304
7	Support diffuser	Stainless steel	AISI 304
8	Coupling	Ductile iron	ASTM A536 65-45-12
9	Impeller	Stainless steel	AISI 304
10	Cylinder	Stainless steel	AISI 304
11	Shaft	Stainless steel	AISI 304
12	Bearing	Tungsten carbide	-
13	Inducer	Stainless steel	AISI 304
14	Inlet & outlet chamber	Stainless steel	AISI 304
15	Base	Cast iron	ASTM 25B

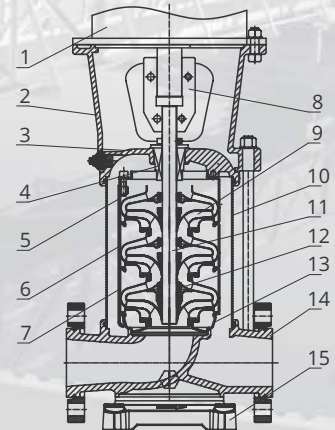

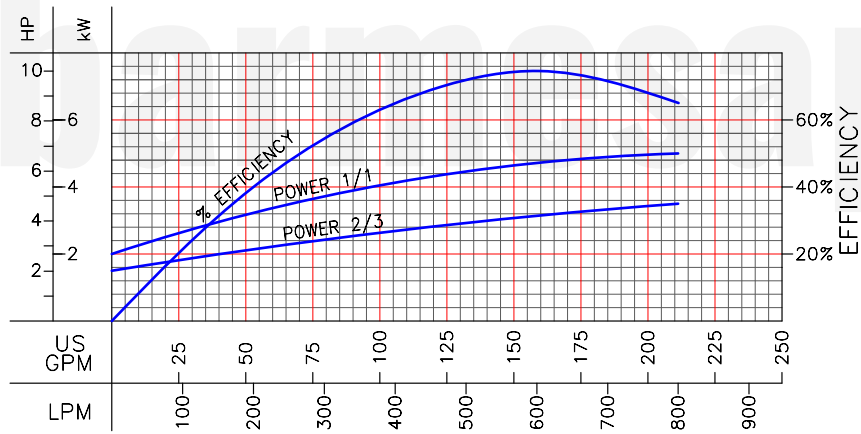
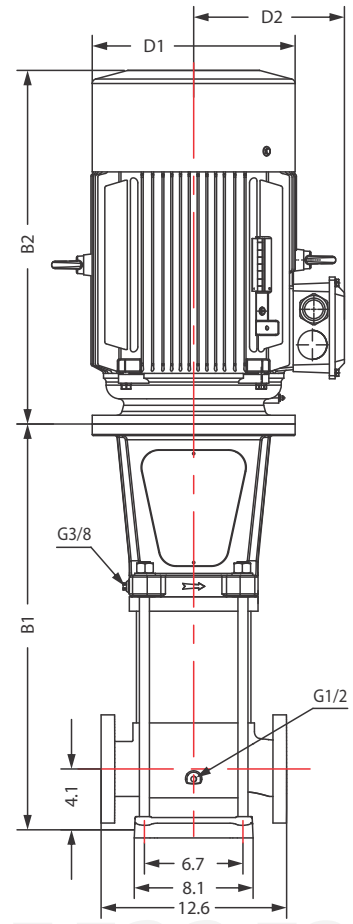
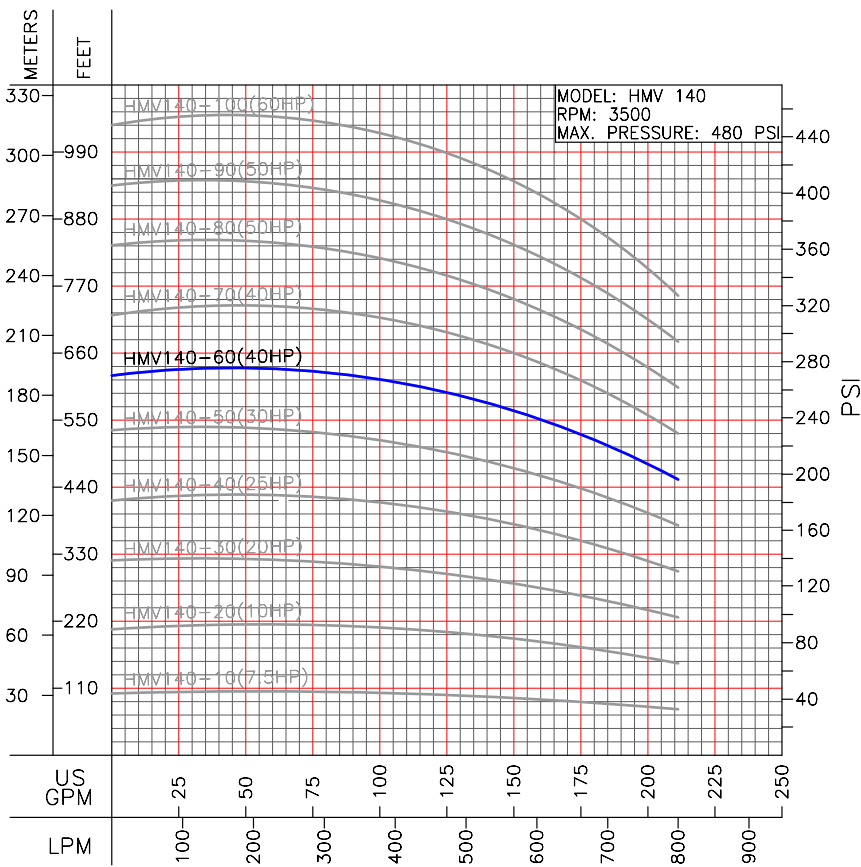

2 1/2" / ANSI / CLASS 300

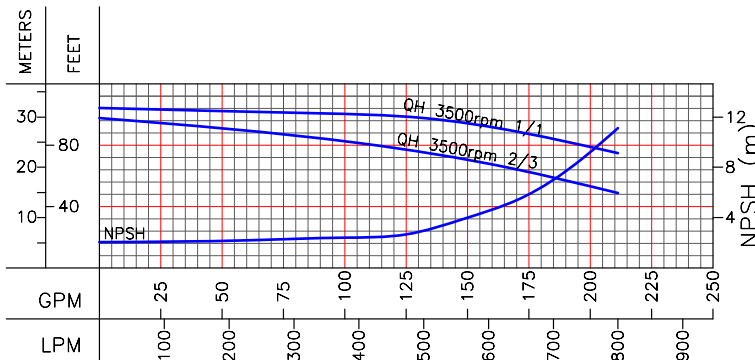
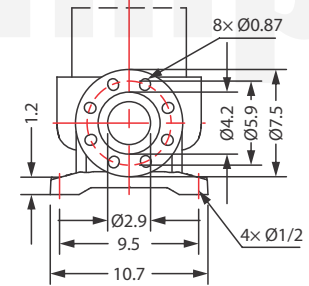

MODEL	HP	STAGES	SIZE (in)				WEIGHT (lb)	
			B1	B2	B1+B2	D1		D2
HMV140-10-1-553	5.5	1	18	16	34	9	7	176
HMV140-10-753	7.5	1	18	18	37	10	8	229
HMV140-20-2-1003	10	2	21	18	39	10	8	251
HMV140-20-1003	10	2	21	18	39	10	8	251
HMV140-30-2-1503	15	3	28	24	52	14	10	408
HMV140-30-2003	20	3	28	24	52	14	10	437
HMV140-40-2-2003	20	4	30	24	54	14	10	441
HMV140-40-2503	25	4	30	25	56	14	10	476
HMV140-50-2-2503	25	5	33	25	58	14	10	481
HMV140-50-3003	30	5	33	25	58	14	11	492
HMV140-60-2-3003	30	6	36	28	64	14	11	496
HMV140-60-4003	40	6	36	28	64	16	12	518
HMV140-70-2-4003	40	7	39	28	67	16	12	522
HMV140-70-4003	40	7	39	28	67	16	12	522
HMV140-80-5003	50	8	41	28	69	16	12	578
HMV140-90-2-5003	50	9	44	28	72	16	12	582
HMV140-90-5003	50	9	44	28	72	16	12	582
HMV140-100-2-6006	60	10	47	29	76	18	13	743
HMV140-100-6003	60	10	47	29	76	18	13	743